











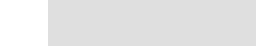
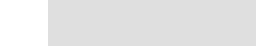
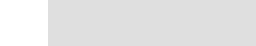
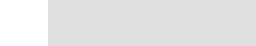
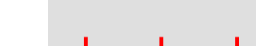

COORDINATSYSTEM

SWEREF99 17 15
RH2000

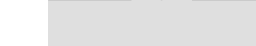
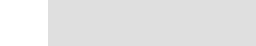
TECKENFÖRKLARING

NY ANLÄGGNING

-  JÄRNVÄG, SPÄRMITT MED LÄNGDMÄTNINGSSTRECK
-  VÄXEL
-  SERVICEVÄG
-  PERSONSKYDDSTÄNGSEL
-  BULLERSKYDDSSKÄRM, PLANK
-  SPÄRNÄRA BULLERSKYDD, LÄG
-  STÖDMUR / GABIONMUR
-  SPONT
-  TRUMMA
-  DAGVATTENLEDNING MED BRUNN
-  NY ANLÄGGNING
-  GRÄNS FÖR JÄRNVÄGSMARK
-  AVGRÄNSNING MELLAN OLIKA TYPER AV MARKANSPRÅK
-  TILLFÄLLIG NYTTJANDERÄTT
-  JÄRNVÄGSMARK MED SERVITUTSRÄTT
-  TRÄD SOM SKYDDAS UNDER BYGGTIDEN
-  INLÖSEN AV BYGGNAD

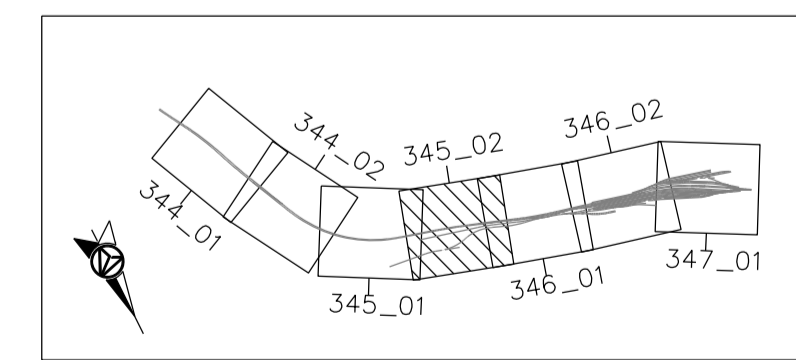
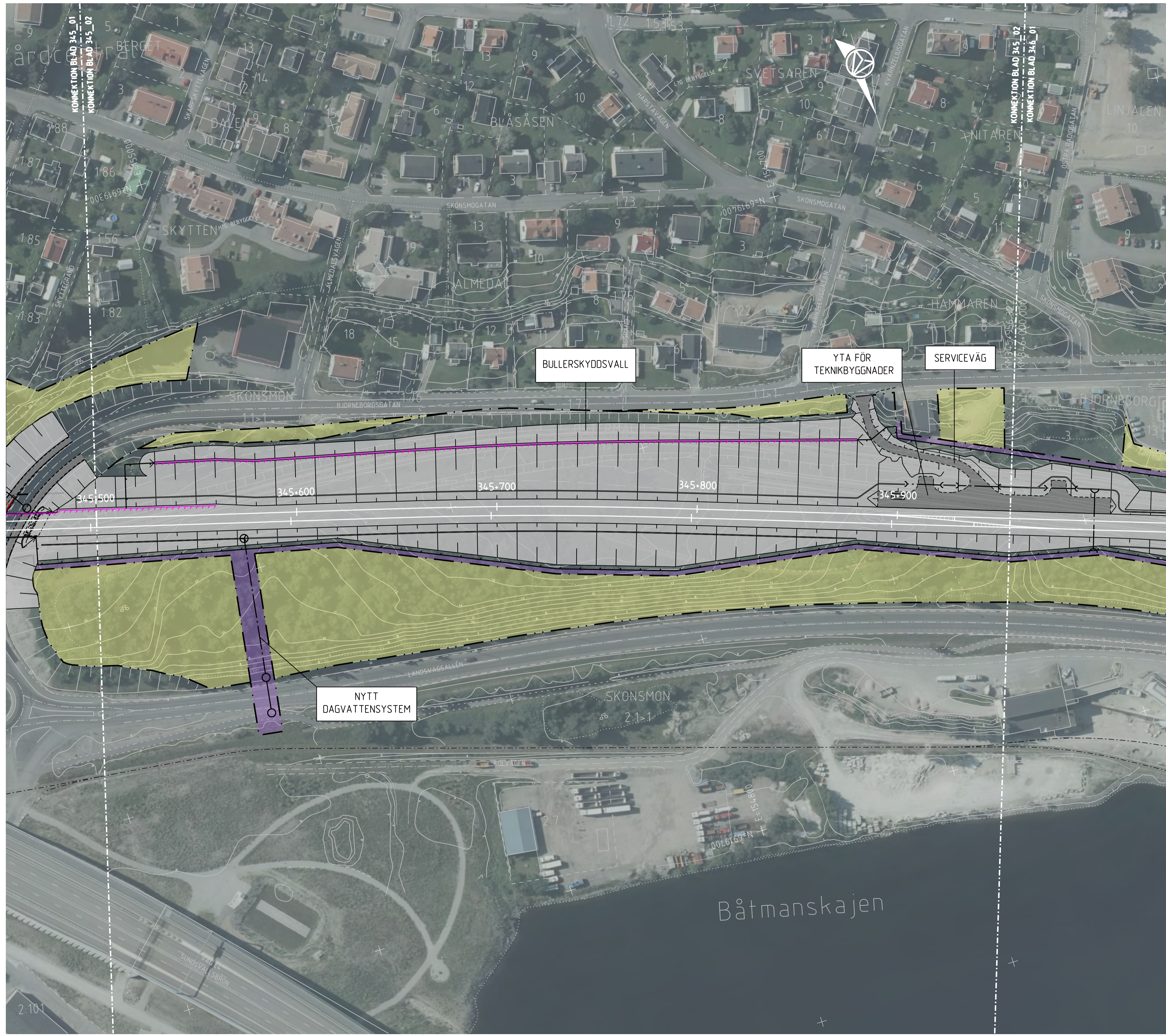

156842-07-PP-344_346-000.dwg
156842-11-XO-1004.dgn
156842-11-PO-344_351-1004.dgn
156842-11-PO-344_351-1001.dgn

A.1
A.2

156842-11-PO-344_347-0004.dgn
156842-11-XO-1003.dgn
156842-11-PO-344_351-1002.dgn
156842-11-PO-344_351-1001.dgn

156842-11-PO-0001.dgn
156842-11-PO-0005.dgn
156842-11-PO-344_351-0001.dgn
156842-11-XO-1001.dgn

Den här ritningen är Trafikverkets egendom. Allt obehörigt
begärande av ritningen beivras enligt lag.
TRAFIKVERKET

Delar av kartmaterial:
© Lantmäteriet, Geodatavärkerket

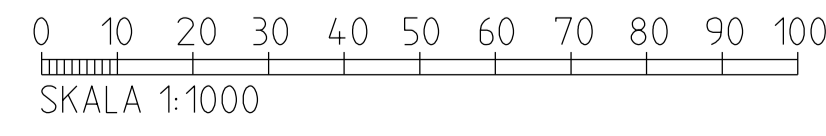

TYP AV PLAN		JÄRNVÄGSPLAN	
LEVERANTÖR	AFRY	AVDELNING	AFRY
SKAPAD AV	M. NYBERG	UPPRÄSNINGSNUMMER	79239901
GRANSKAD AV	M. NYBERG	KONSTRUKTIONSNUMMER	
LEVERANS/ÄNDRINGS-FM		TEKNIKÖVERGRIPANDE	
GRANSKINGSSTATUS / SYFTE		GRANSKINGSSTATUS / SYFTE	
HANDLESTYP		HANDLESTYP	
ANLÄGGNINGSTYP		ANLÄGGNINGSTYP	
FLÖKE TER-METER	345-500 - 346-000	BLAD	234
RITINGSNUMMER PROJEKT	156842-00-101-0345-1002	BLAD	NÄSTA BLAD
BLAD	002	BLAD	001
REF.		ANM.	