

# FÖRKLARINGAR

- BEFINTLIG MARKNIVÅ
- NYTT VÄGRÄCKE/GC-RÄCKE
- VK X.XX VÄGKANT, X METER FRÅN LINJE 202-GC
- VK\_GC X.XX VÄGKANT GC-BANA, X METER FRÅN LINJE 202-GC
- VM X.XX VÄGMITT (BEFINTLIG), X METER FRÅN LINJE 202-GC
- Ny\_VM X.XX NY VÄGMITT, X METER FRÅN LINJE 202-GC
- Bef\_VM BEFINTLIG VÄGMITT (VID VÄGMITTSFÖRSJUTNING)
- x.xx TVÄRFALL

# ANVISNINGAR

TVÄRSEKTIONER AVSER LINJE 202-GC

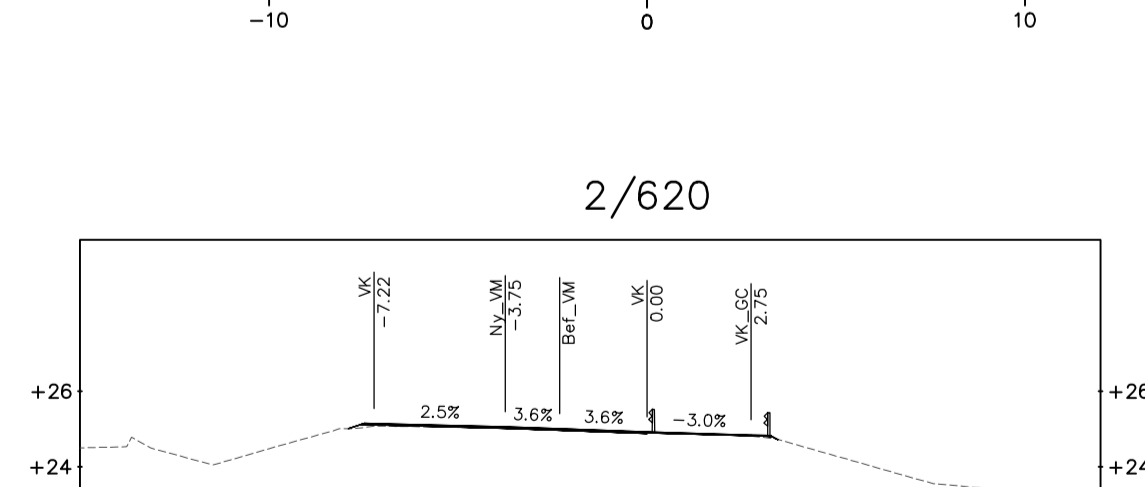
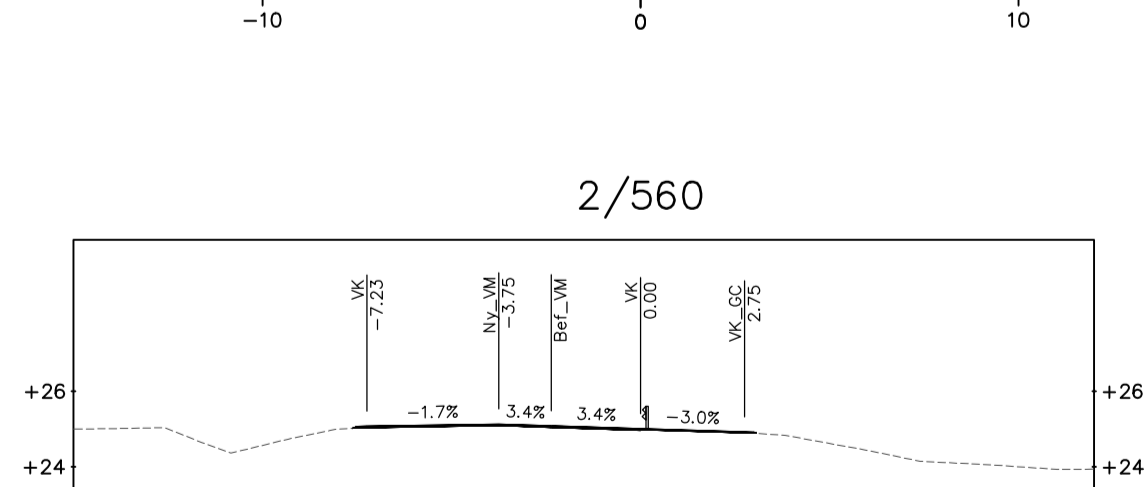
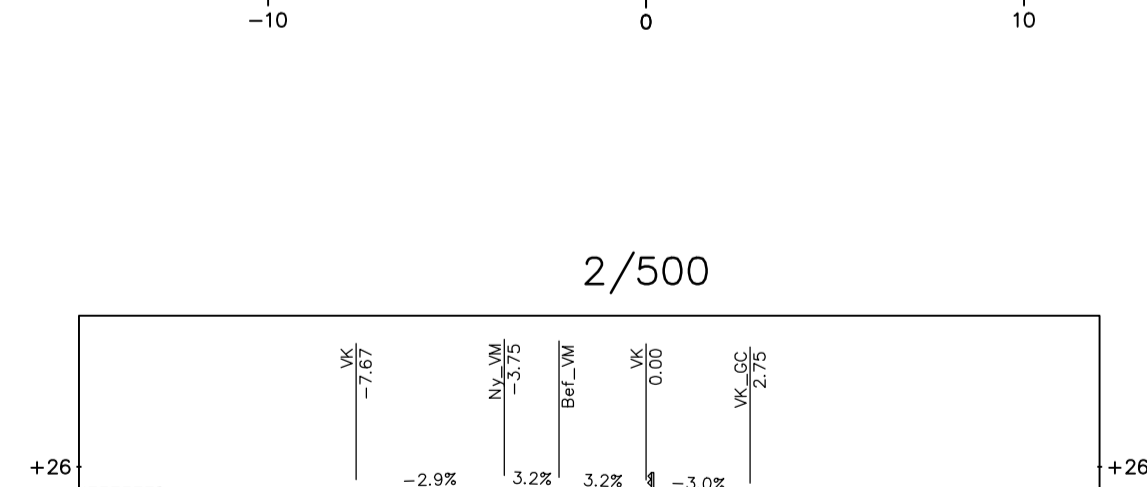
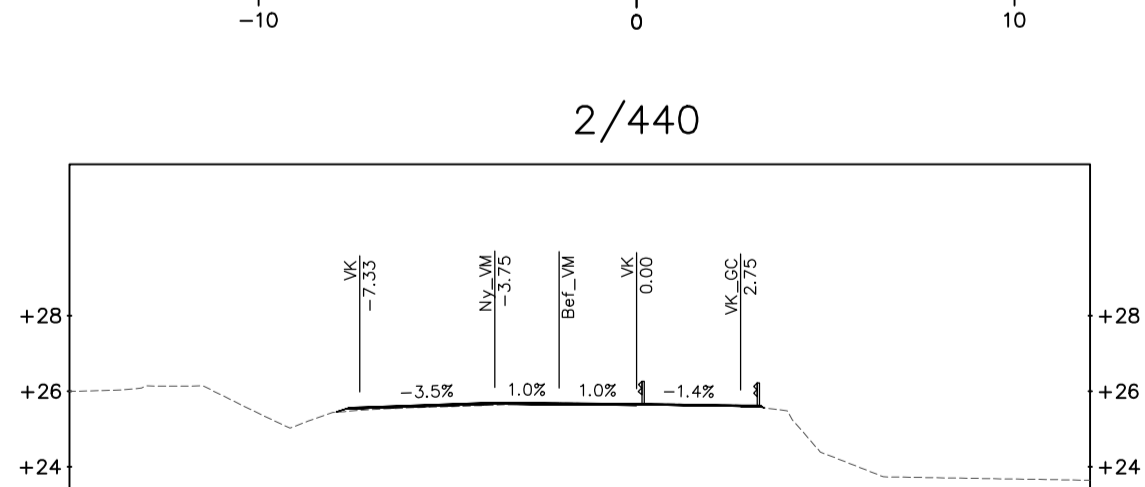
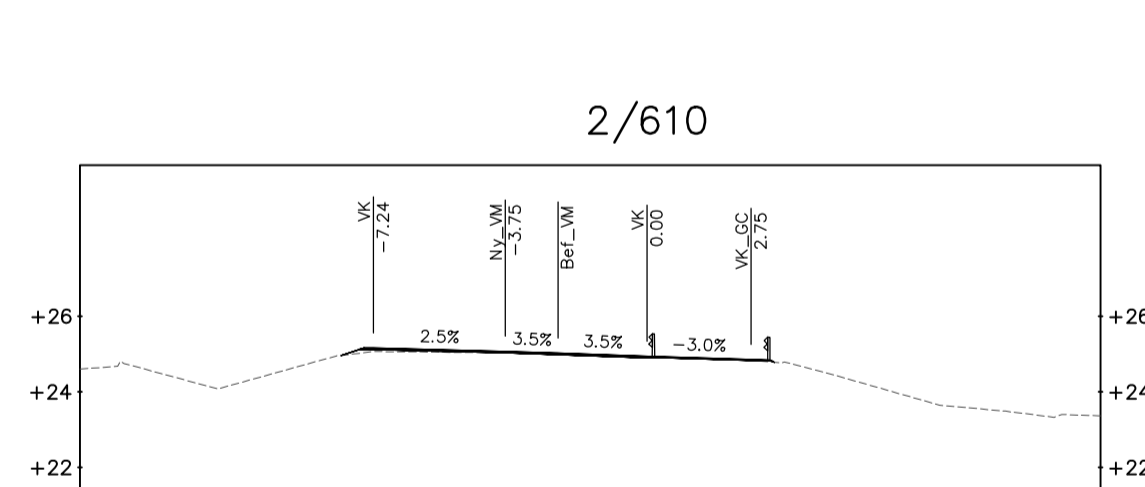
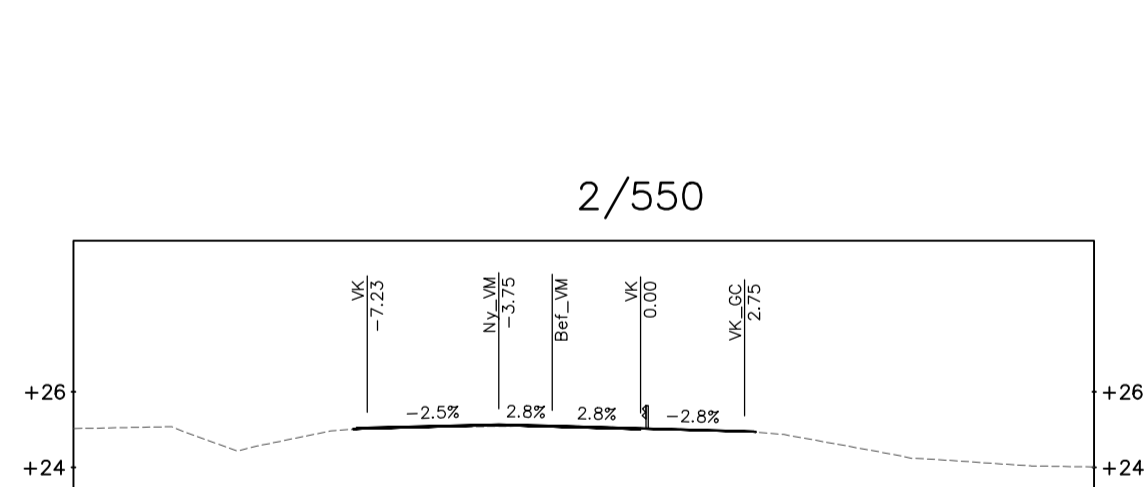
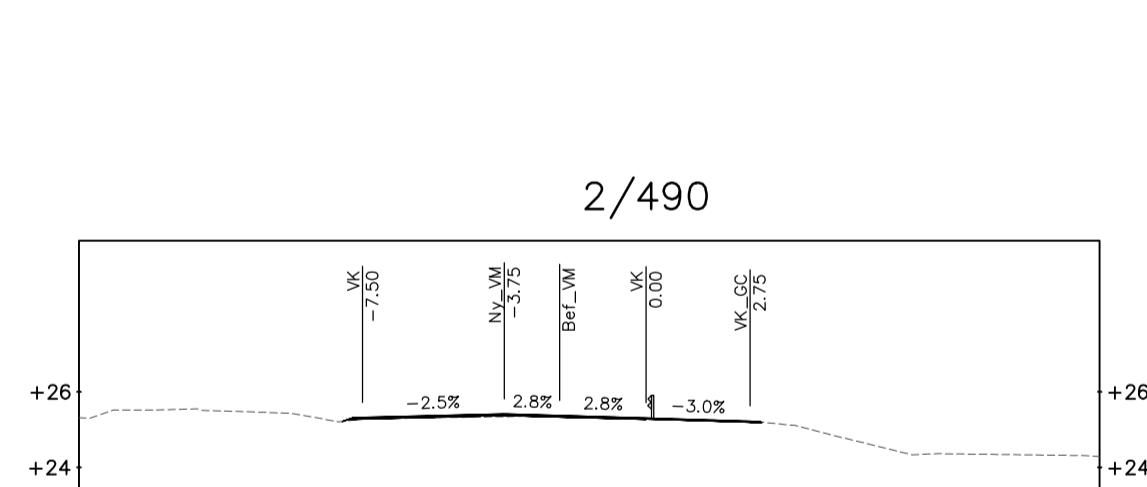
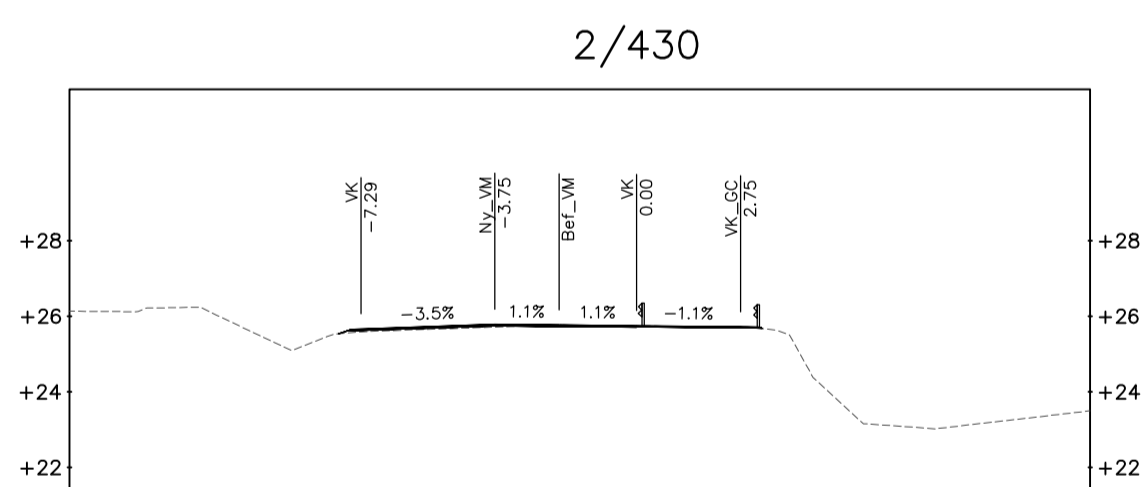
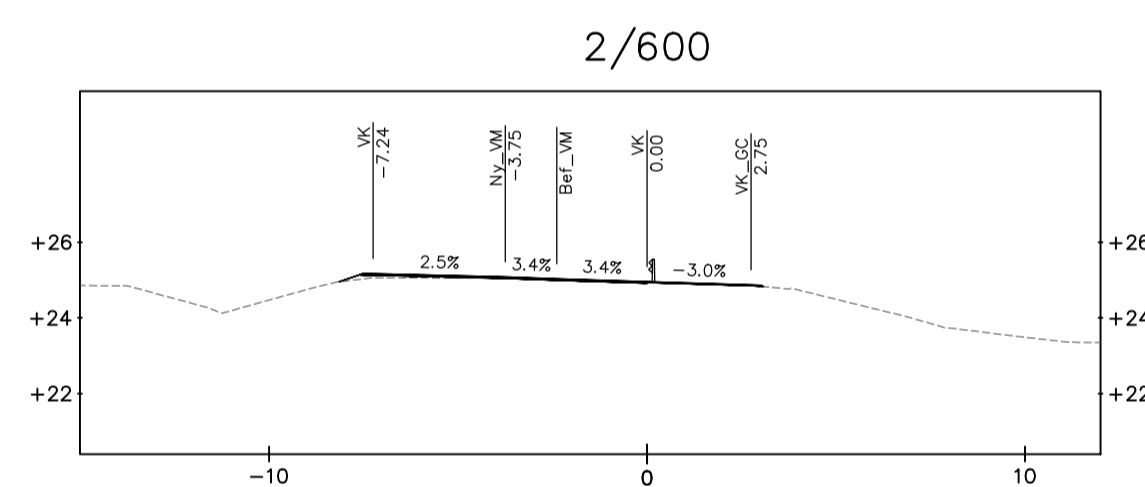
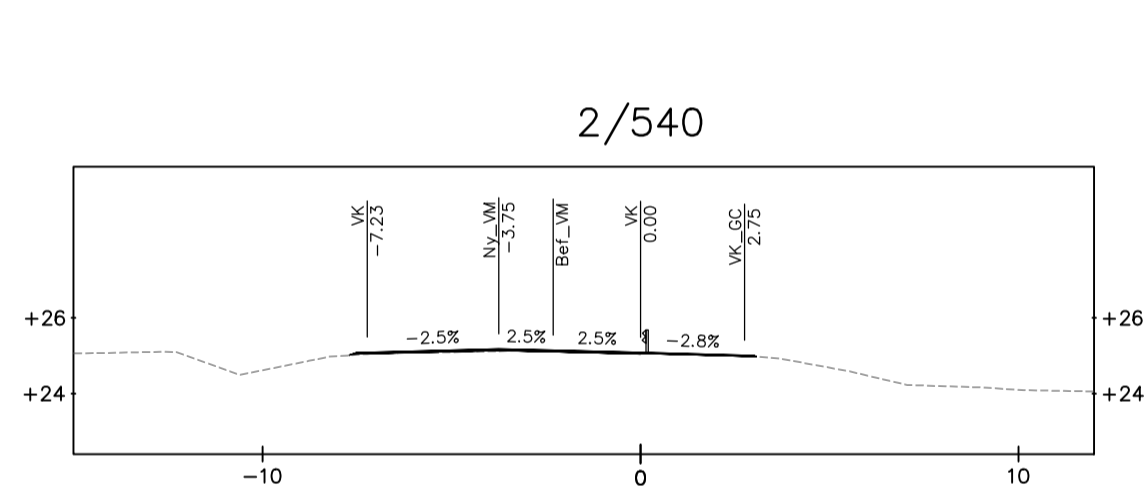
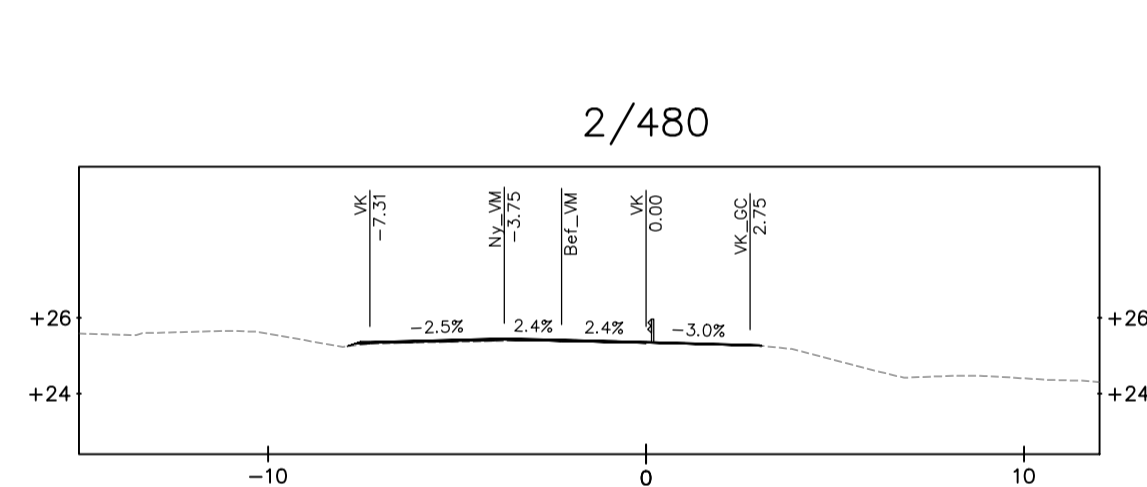
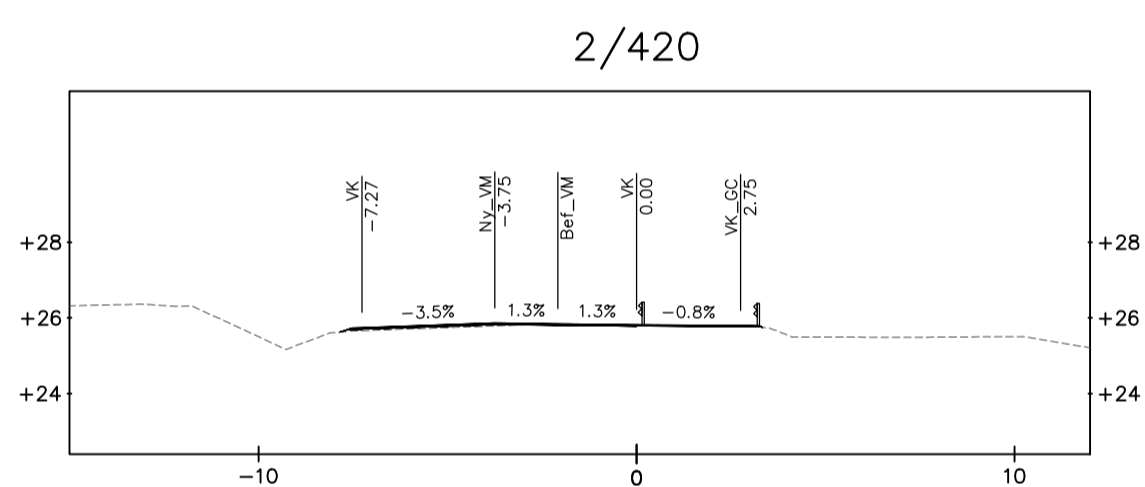
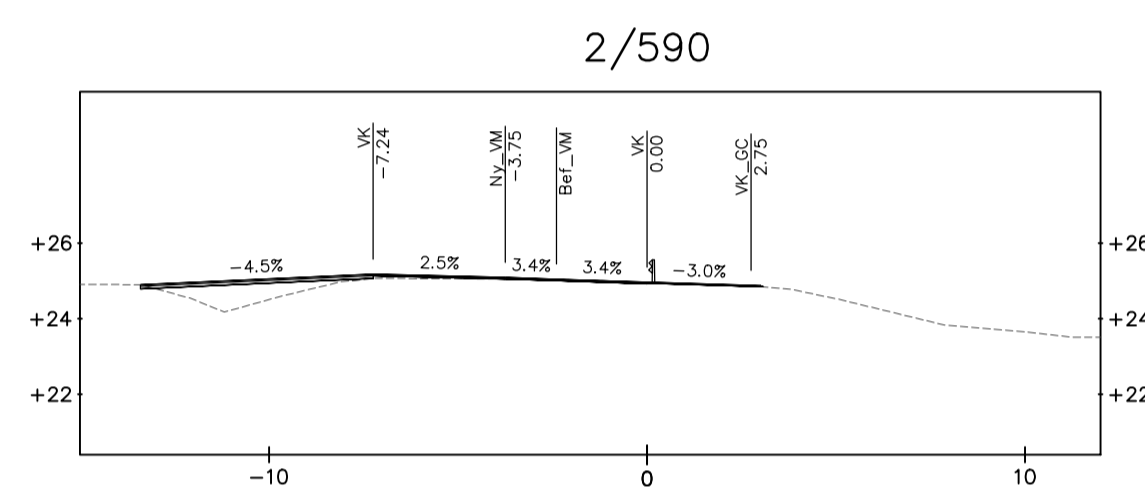
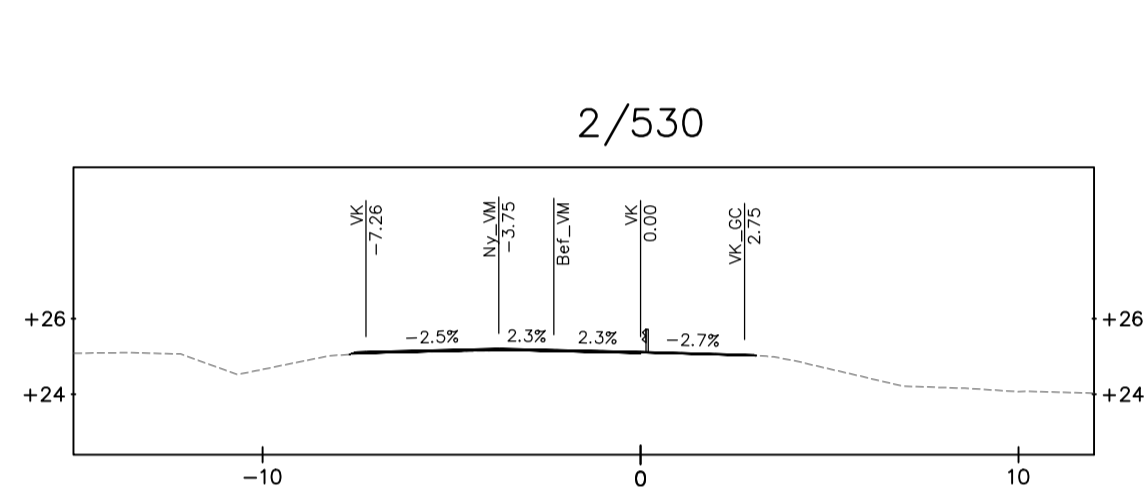
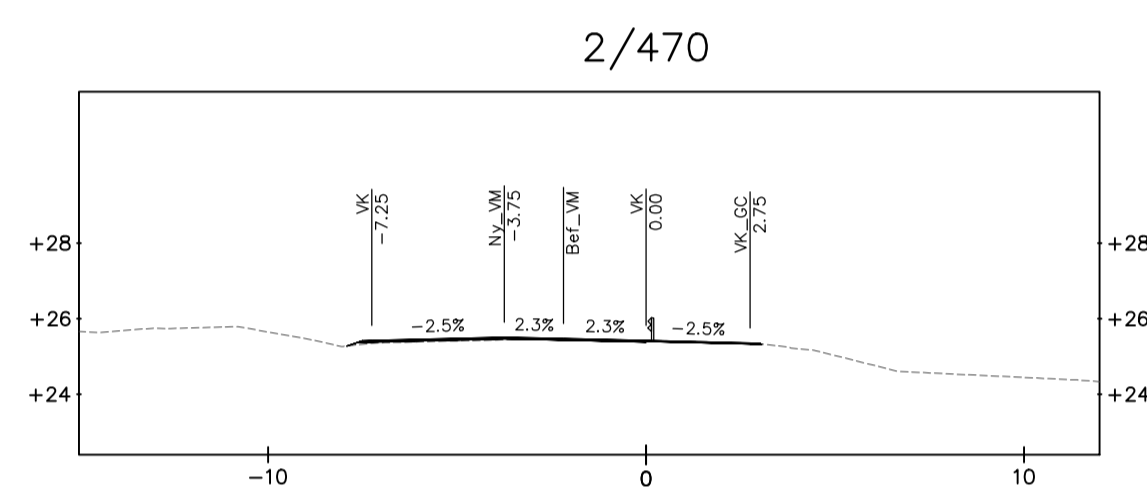
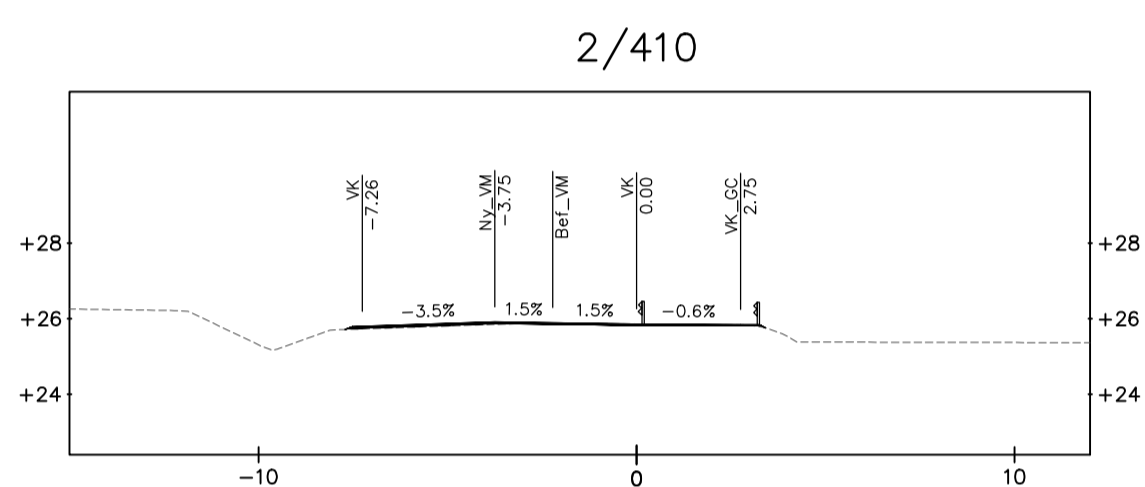
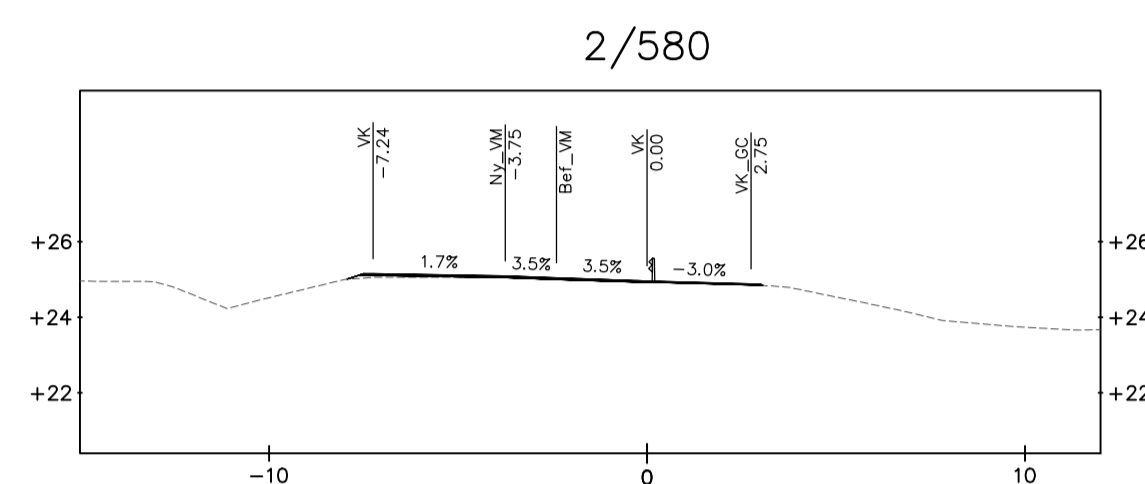
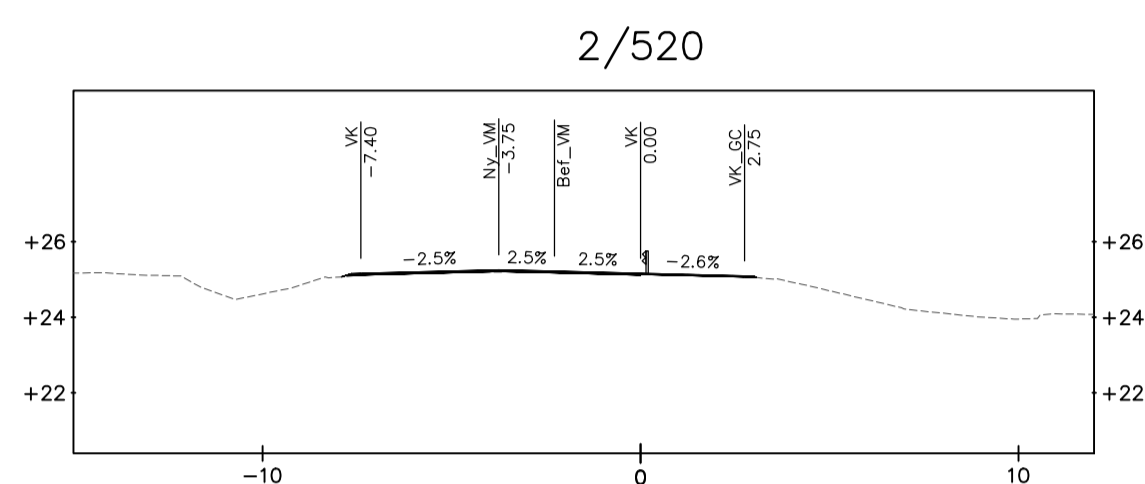
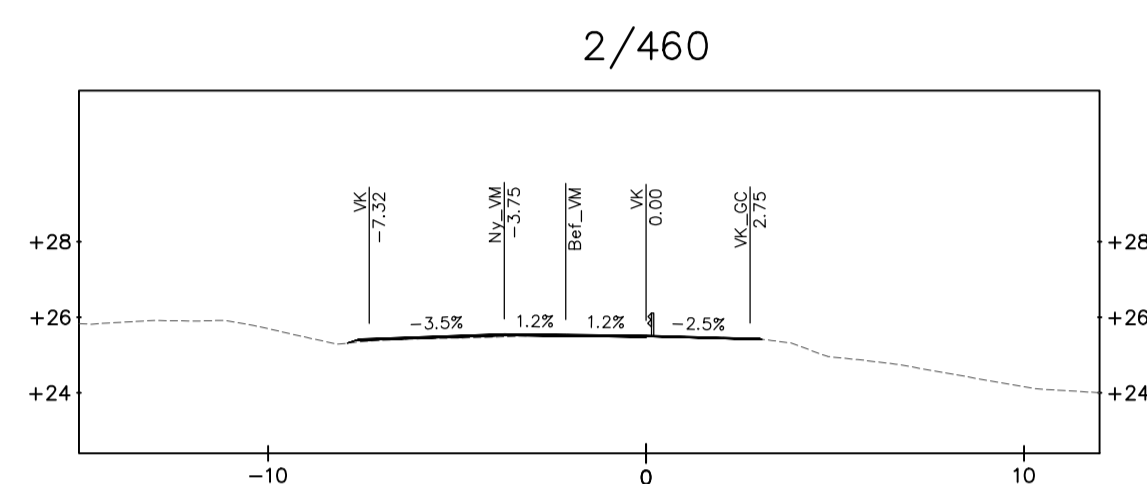
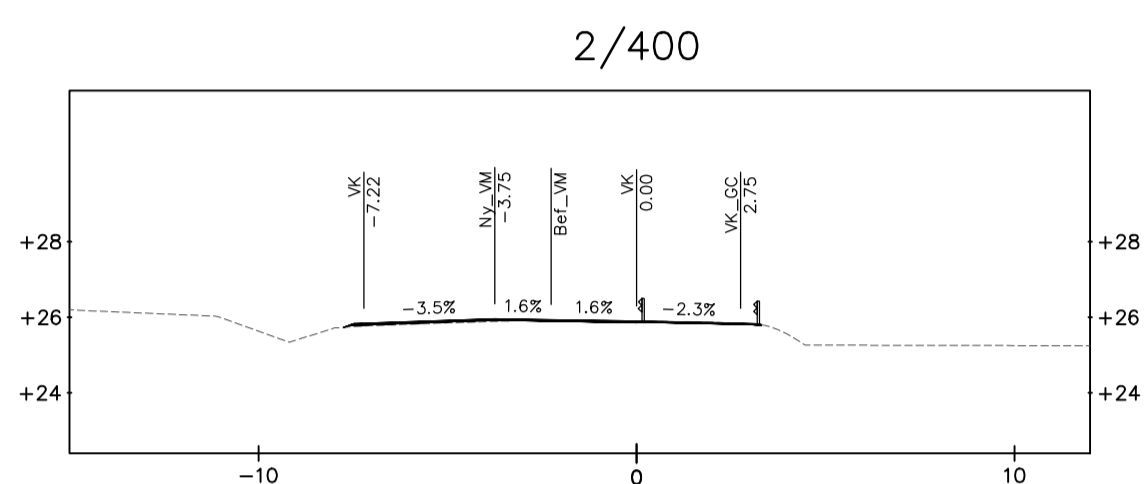
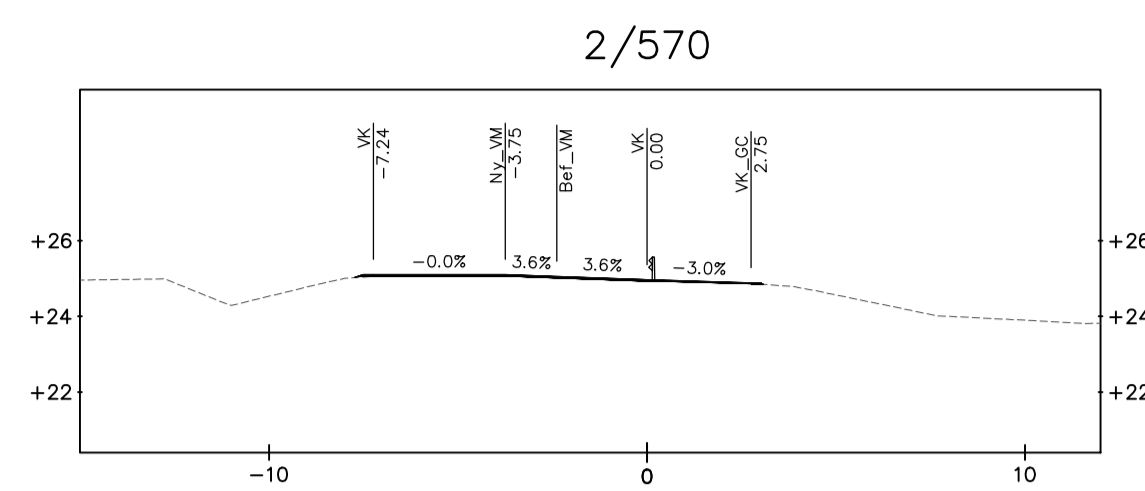
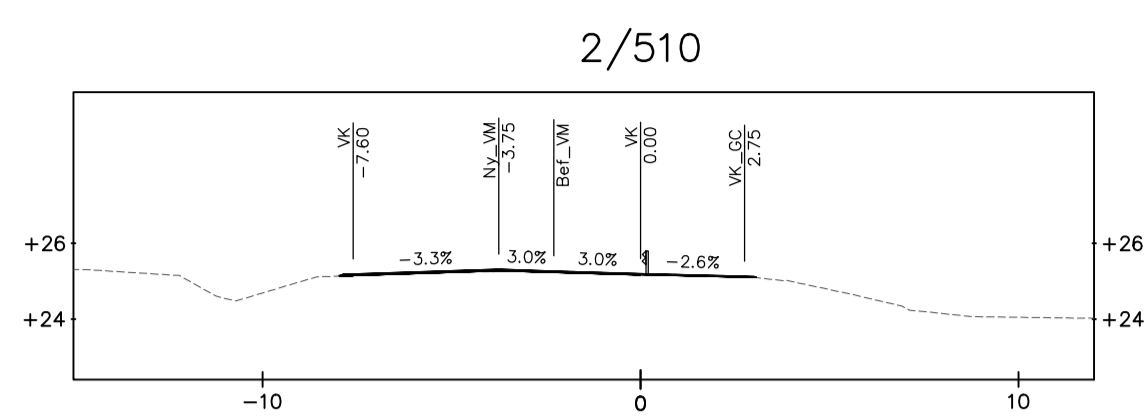
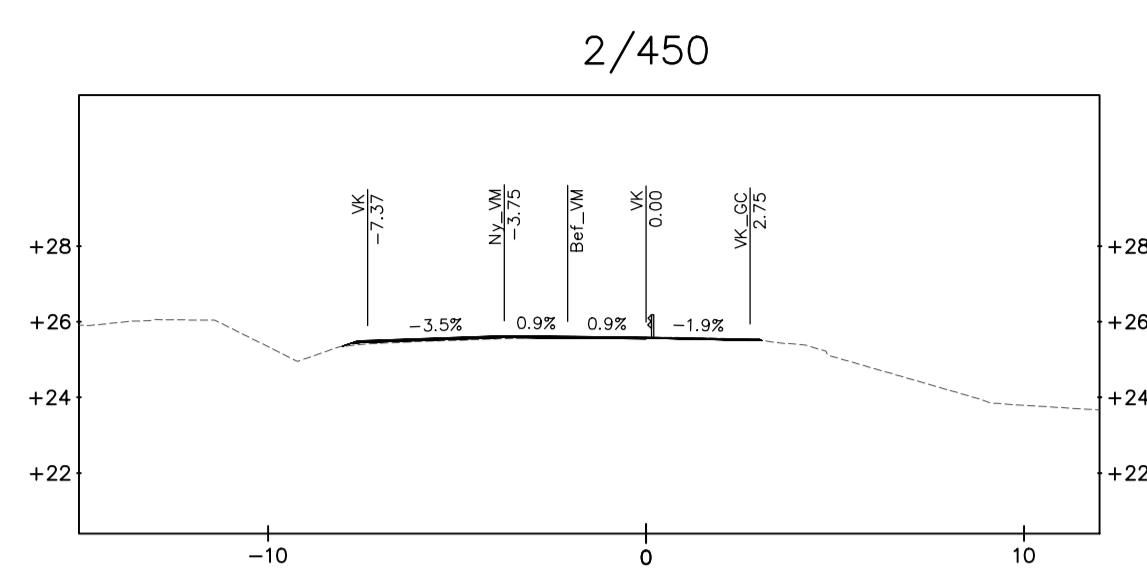
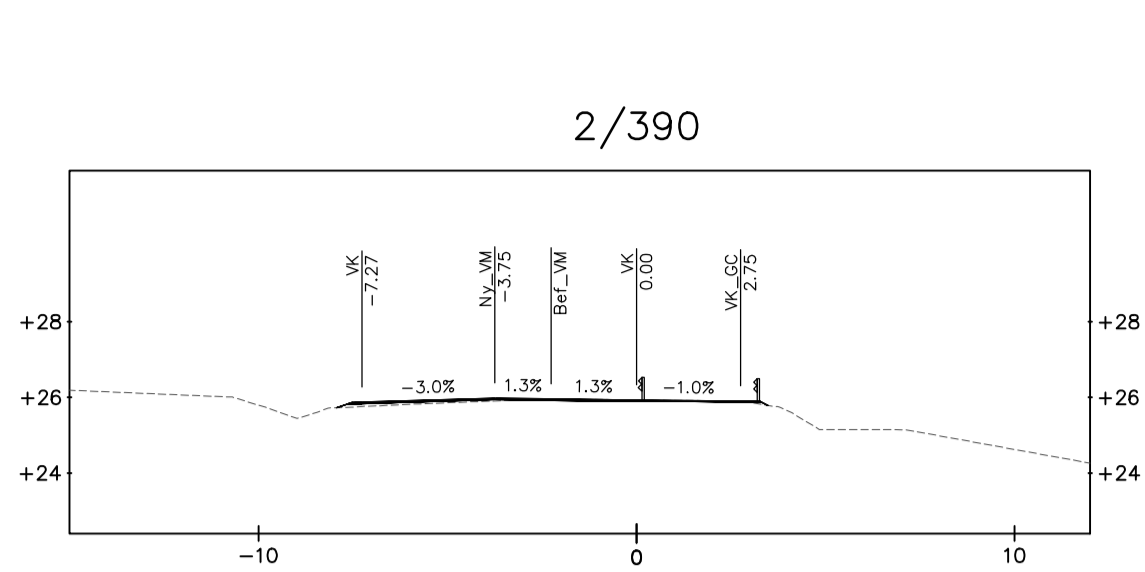

# KOORDINATSYSTEM

PLAN: SWEREF 99 18 00  
HÖJD: RH 2000

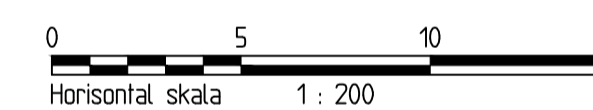

TYP AV PLAN		<b>VÄGPLAN</b>	
GRANSKNINGSSTATUS / SYFTE			
HANDLINGSTYP			
<b>GRANSKNINGSHANDLING</b>			
DATUM		LEVERANS / ÄNDRINGS-PM	
2024-04-04			
OBJEKT			
<b>GC-VÄG TIERP - TIERPS KYRKBY</b>			
DELOMRÅDE / BANDEL			
TIERP			
ANLÄGGNINGSGDEL			
TIERP - TIERPS KYRKBY			
OBJEKTNUMMER / KM	KONSTRUKTIONNUMMER		
169470	2013741		
BESTÄLLARE	LEVERANTÖR		
TRAFIKVERKET	SYSTRA		
SKAPAD AV	UPPRAGSNUMMER		
M. VALL	2013741		
GODKÄND AV	ÄNDELNING		
J. NILSSON			
RITNINGSTYP			
<b>SEKTIONS-RITNING</b>			
TEKNIKOMRÅDE / INNEHÅLL			
<b>VÄGUTFORMNING OCH TRAFIK</b>			
BESKRIVNING			
<b>TVÄRSEKTIONER LINJE 202-GC</b>			
2/390 - 2/620			
SKALA	FORMAT	FÖRVALTNINGSNUMMER	
1:200	A1		
RITNINGNUMMER	BLAD	NÄSTA BLAD	BET
2 02 T 09 11			